

Multi Format LCD Monitor

User Manual



LVB-Series

CAUTION	3
FEATURES	5
CONTROLS, INDICATORS AND CONNECTIONS	6
MENU BASIC OPERATION	10
PICTURE MENU	12
DISPLAY MENU	15
SETUP MENU	16
INFO MENU	18
INPUT SUPPORT MODE.....	19
MECHANICAL DIMENSION	21

Before operating the set, please read this manual carefully.

WARNING:

To reduce the risk of electric shock does not remove cover (or back). No user serviceable parts inside. Refer servicing to qualified service personnel. To prevent fire or shock hazard, do not expose the rear of the set to rain or moisture. Do not rub or strike the Active Matrix LCD with anything hard as this may scratch, mark, or damage the Active Matrix LCD permanently.

Unauthorized tampering with the inside of the monitor invalidates the warranty.

The manufacturer shall not warrant for any damage caused by improper maintenance and/or repair. Work by third parties.

Important safeguards for you and your new product:

Your product has been manufactured and tested with your safety in mind. However, improper use can result in potential electrical shock or fire hazards. To avoid defeating the safeguards that have been built into your new product, please read and observe the following safety points when installing and using your new product and save them for future reference.

Read Instructions

Follow Instructions

All operating and use instructions should be followed.

Retain Instructions

The safety and operating instructions should be retained for future reference.

Heed Warnings

All warnings on the product and in the operating instructions should be adhered to.

Cleaning

Disconnect the unit from the electricity supply before cleaning. Do not use abrasive cleaners. Use a damp cloth for cleaning.

Water and Moisture

Do not use this apparatus near water.

Transporting Product

A product and cart combination should be moved with care. Quick stops, excessive force and uneven surfaces may cause the product and cart combination to overturn.

Attachments

Do not use attachments not recommended by **Boland** as they may cause hazards.

Ventilation

Do not block any of the ventilation openings.

Install in accordance with the manufacturer's instructions.

Power Sources

This product should be operated only from the type of power source indicated on the marking label. If you are not sure of the type of power supply to your home, consult your supplying dealer.

Power Lead Polarization

This product is equipped with a three-wire grounding-type cord. This is a safety feature. Do not defeat the safety purpose of the grounding-type cord.

Power Cord Protection

Power-supply cords should be routed so that they are not likely to be walked on or pinched by items placed upon or against them, paying particular attention to cords at plugs, convenience receptacles and the point where they exit from the product.

Outdoor Cable Grounding

If an outside antenna or cable system is connected to the product, be sure the antenna or cable system is grounded so as to provide some protection against voltage surges and built-up static charges. A “face plate” also needs to be installed with an isolating capacitor to prevent any damage from static.

Lightning

For added protection for this product during a lightning storm, or when it is left unattended and unused for long periods of time, unplug it from the wall outlet and disconnect the antenna or cable system. This will prevent possible damage to the product due to lightning and power-line surges.

Power Lines

An outside antenna system should not be located in the vicinity of overhead power lines or other electric light or power circuits, or where it can fall into such power lines or circuits. When installing an outside antenna system, extreme care should be taken to avoid contact with such power lines or circuits, as contact with them might be fatal.

Earthing the product

This product must be earthed properly to comply with the safety regulations in the country of use. If you are unsure of these regulations, please consult a qualified electrician.

Servicing

Do not attempt to service this product yourself as opening or removing covers may expose you to dangerous voltages or other hazards. Refer all servicing to qualified service personnel. If the Set does not operate properly, switch it off and call your dealer.

Damage Requiring Service

Isolate this product from the mains supply and refer servicing to qualified service personnel under the following conditions:

- A. If the power-supply cord or plug is damaged.*
- B. If the glass front has been damaged.*
- C. If there is ingress of water between the glass and the LCD screen.*
- D. If the product does not operate normally by following the operating instructions. Adjust only those controls that are covered by the operating instructions as an improper adjustment of other controls may result in damage and will often require extensive work by a qualified technician to restore the product to its normal operation.*
- E. If the product has been dropped or the cabinet has been damaged.*
- F. If the product exhibits a distinct change in performance.*

Safety Check

Upon completion of any service or repairs to this product, ask the service technician to perform safety checks to determine that the product is in proper operating condition and the front seal is intact.

Mounting

The product should be mounted on a wall only as recommended in the instructions.

Power

This set operates on an AC supply; the voltage is as indicated on the label on the Manual. This appliance must be earthed at all times through the chassis as well as through the power lead.

This product is the multi-format Digital LCD Panel to display various kinds of digital video input signal as HD/SD-SDI/DVI/HDMI Digital and analog signal such as Composite/S-Video/RGB/PC-RGB/ Component.

This is also High Definition Broadcasting Monitor which can make it available to do output of stable video signal with the menu of considering convenient user interface and the easy control for brightness and color.

- *HD/SD SDI 2INPUT/2 OUTPUT.*
- *Color Temperature – User, VAR, 11000K, 9300K, 6500K, 5400K, 3200K*
- *Over Scan/Zero Scan/Under Scan/Pixel to Pixel*
- *PIP (Picture In Picture)/PIP Blend*
- *Integrated DVI (HDCP) function.*
- *HDMI (HDCP) function.*
- *Supports VESA DDC2B and a subset of VESA standards.*
- *Single board is suitable for mounting behind an LCD panel.*
- *Supported RS-232C, RS-422.*
- *Supported External GPI Control (RJ-45).*
- *OSD: Graphic based OSD, 6 Languages (UNICODE System).*
- *LCD Dimming Control*
 - *Manual Dimming Level Control.*
- *UMD*
- *Auto Calibration: CA-210,CA-310(Minolta) / K-10(Klein)*
- *ETHERNET: Network System Controller / Update*
- *Blue only / Mono*

LVB17 Front

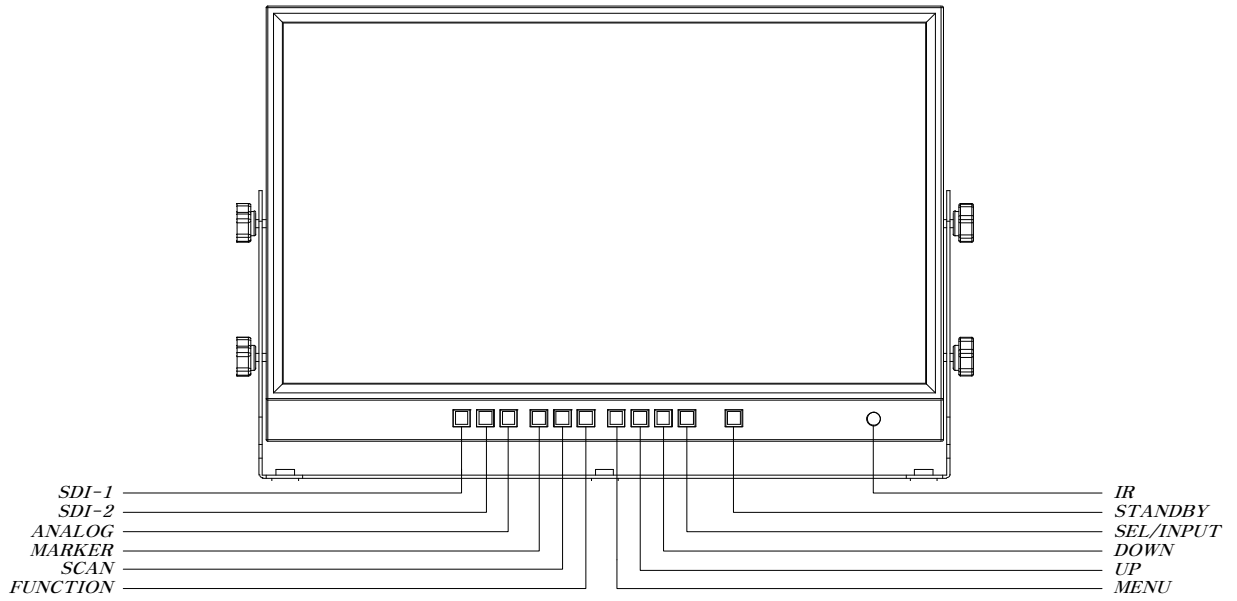

LVB17 Rear

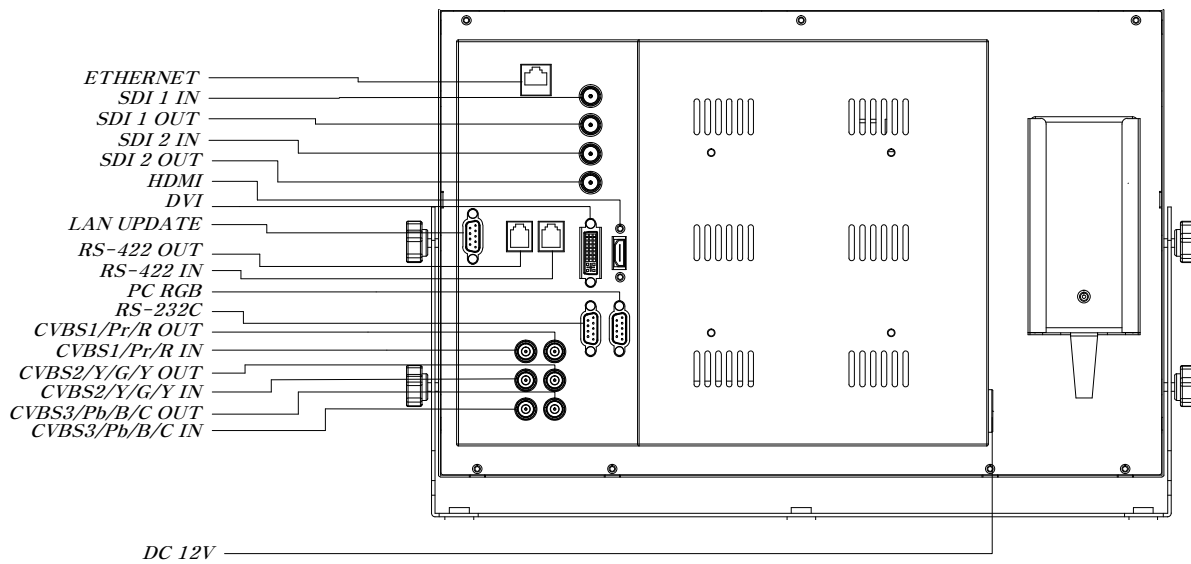

LVB23 Front

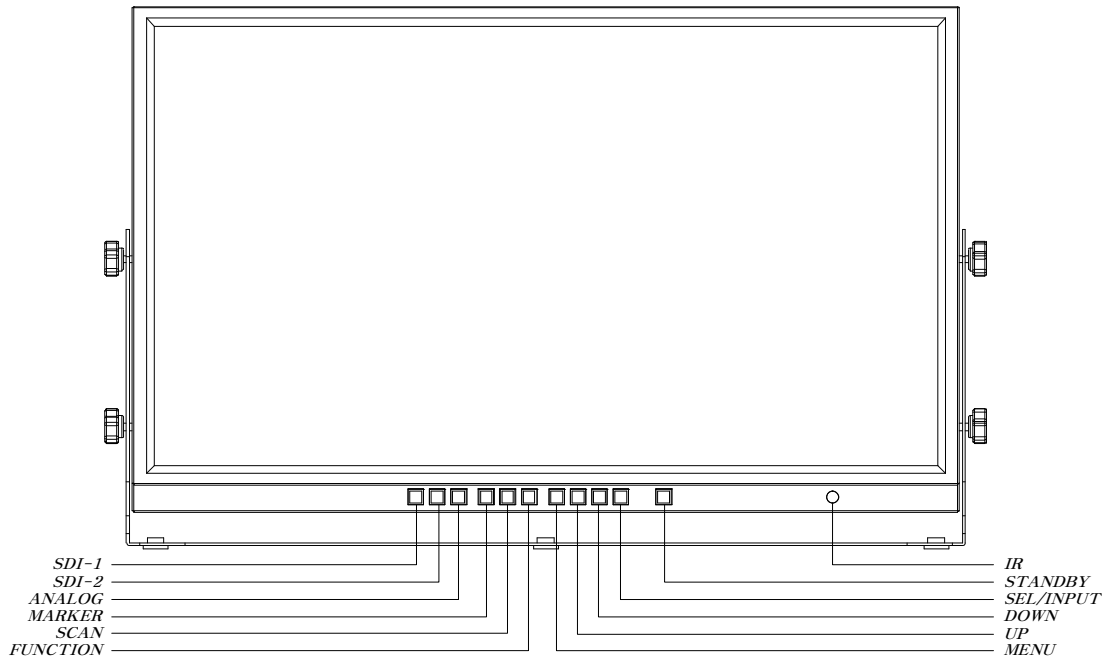

LVB23 Rear

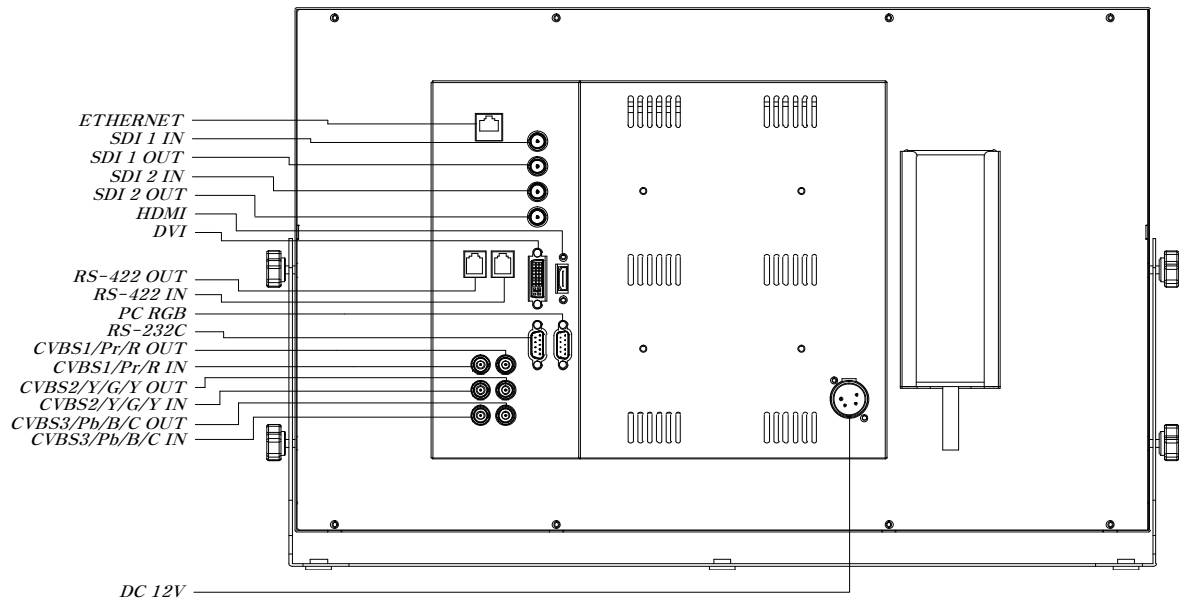

Front Keys Arrangements

- **STANDBY**

Power ON/OFF Button. This button is operated after being pressed about 3 seconds.

- **SDI 1 / SDI 2**

Select SDI 1/ SDI 2 source directly

- **ANALOG**

Select ANALOG source directly ('CVBS1' ->'CVBS 2' ->'CVBS 3'->'S-video'->'G.B.R'->'Y.Pb.P' ->'PC'->'HDMI'->'DVI')

- **MARKER**

Draw Marker on Screen (Off -> 16:9 -> 4:3 ... -> 2.35:1)

- **SCAN**

Activates 'H & V' blanking display 'H DELAY' -> 'V DELAY -> 'HV DELAY' -> OFF

- **FUNCTION 1**

Executes functions of user selected

(UNDEF, Aspect, Mono/Blue, Audio Group/Channel/Mute, Time code, Still image, Caption, Aspect Marker, Area Marker, PIP func & Input, Zoom, Gamma Select, WFM Line Select.)

- **MENU**

Activates main OSD menu

Navigates higher menu in main OSD menu

Exits OSD menu

- **DOWN**

Decreases sound volume of speaker

Decreases values of user menu in main OSD menu

Executes function (by OSD help commands) in main OSD menu

- **UP**

Increases sound volume of speaker.

Increases values of user menu in main OSD menu

Executes function (by OSD help commands) in main OSD menu

- **SEL/INPUT**

Activates OSD menu of input source selecting

Changes input source by selecting

Executes functions (by OSD help commands) in main OSD menu

Activates child menu

REAR Panel

- **SDI 1/SDI 2 IN**
HD SDI / SD SDI Input
- **SDI 1/SDI 2 OUT**
SDI 1, SDI 2 Loop Out
- **RS-232C IN**
Update /Auto color calibration
- **LAN UPDATE**
LAN Board Update
- **DVI**
DVI Digital Input
- **HDMI**
High Definition Multimedia Input
- **PC-RGB**
Analog PC-RGB Video Input
- **CVBS1/Pr/R In**
CVBS 1, Component Pr, GBR(SOG sync) R Input
- **CVBS2/Y/G/Y In**
CVBS 2, Component Y, GBR(SOG sync) G, S-Video Y Input
- **CVBS3/Pb/B/C In**
CVBS 3, Component Pb, GBR(SOG sync) B, S-Video C Input
- **ETHERNET**
Network System Control/ Firmware Upgrade
- **RS422 IN/OUT**
Monitor System Control
- **DC 12V IN**

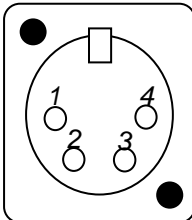

PIN NO	Description
1	GND
2, 3	
4	+ 12V

MENU Basic Operation

In this menu system, there are several ways to customize the menu settings provided. Most menus consist of three levels to set up the options, but some require greater depth for the variety of settings. If you press the **MENU** button, only the first and second level of the menu system will appear on the monitor screen. The third level can be displayed by pressing **SEL/INPUT**. If a menu has more than three levels, the pop-up dialogue box will be displayed as the fourth or fifth level.

To show and remove the Menu

Press the **MENU** button to display the menu. A second press of the **MENU** button will take you back to monitor viewing.

To go to the next level

Press **SEL/INPUT** button.

To go back to the previous level

Press **MENU** button



Typical Menu Operation

1. Press **MENU** button: The main menu will appear.
2. Use **Adjust / Take** button Turn Right/ Left to select the desired menu option (icon).
3. While the desired menu option is selected, press **SEL/INPUT** to move to the second level.
4. Use **Adjust / Take** button Turn Right/ Left to select the second menu option.
5. Press **SEL/INPUT** to move to the third level: Some menu options require additional steps.
6. Press **MENU** to return to the previous menu to return to monitor viewing.

Turning On the Monitor

1. First, connect power cord correctly. At this moment, the monitor switches to standby or power on mode. In standby mode, in order to turn monitor on, press the **ST-BY** button.
2. Select the viewing source by using **SEL/INPUT** button on Keypad in front of monitor

On Screen Menus Language Selection

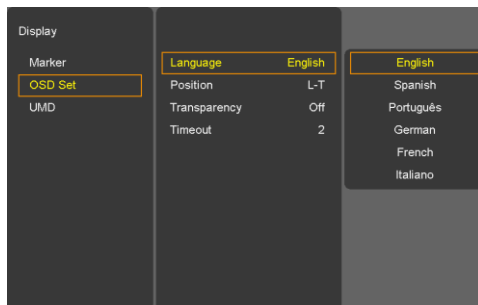

- Display -> OSD Set -> Language
- The menus can be shown on the screen in the selected language.
- Supported Language: English, Spanish, Portuguese, German, French, Italian

How to Select Video Source by OSD

1. Press the **SET/INPUT** button and then **UP/DOWN** button to select each video source.
2. Press the **SET/INPUT** button to go to desired video source.
3. If Input Name is enabled, The **SET/INPUT** button goes into input name edit mode instead of selecting source.

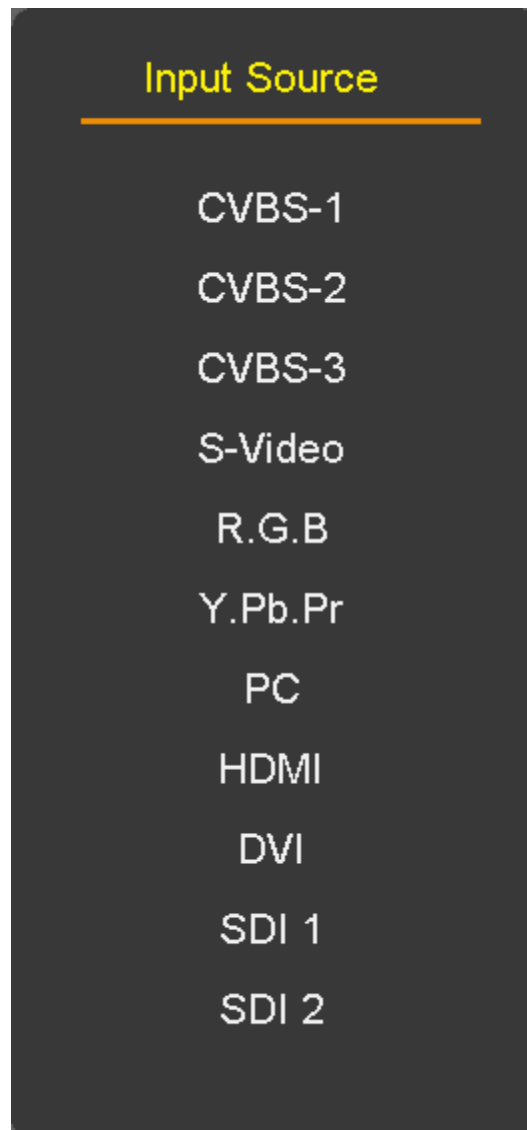

Video Menus of each Input modes

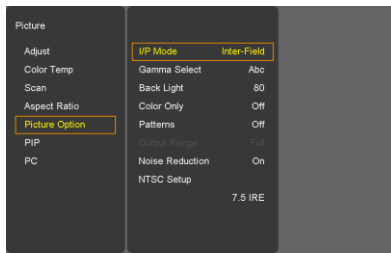

< Video (NTSC) Picture menu >

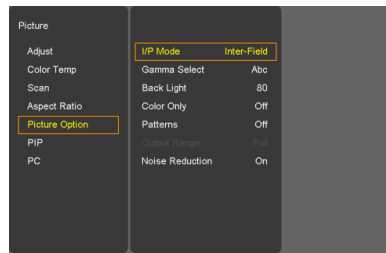

< PC Picture menu >

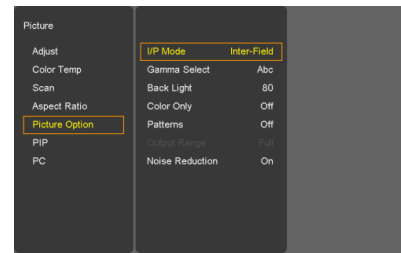

< SDI, HDMI Picture menu >

Adjust

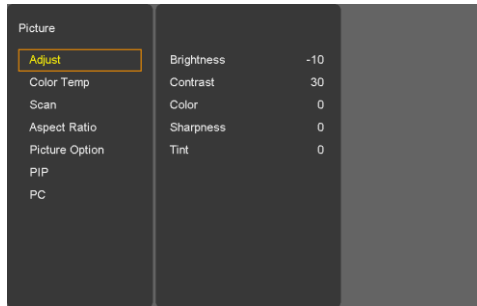

- Adjust the values of Brightness, Contrast, Color, Tint and Sharpness directly from -50 to 50

Contrast, Brightness, Sharpness, Color (All Sources), Tint (without PC, DVI, HDMI, Component), Phase (Component).

Color Temp

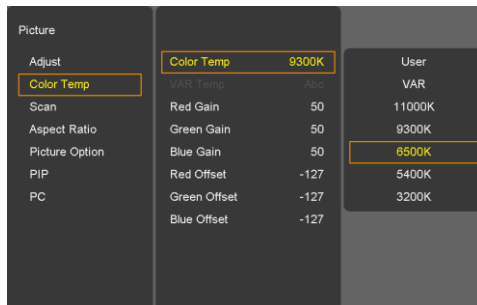

- For Setting the Color temperature or adjusting RGB Gain / Offset value directly

- User (User setting RGB gain value), VAR(3200K ~ 11000K), Often used value(11000K, 9300K, 6500K, 5400K, 3200K)

SCAN

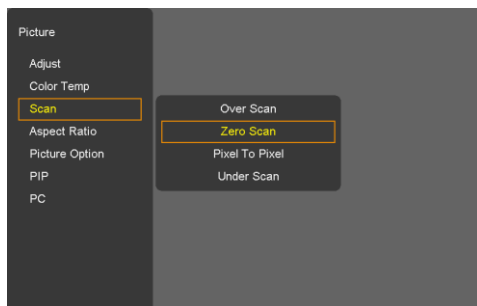

1. Over Scan – 95% input size and fit the selected display size
2. Zero Scan – 100% Input size and fit the selected display size
3. Under Scan – 105% Input size and fit the selected display size
4. Pixel to Pixel – Display size is an input size. If input resolution is bigger than panel size, fit the panel size

Aspect

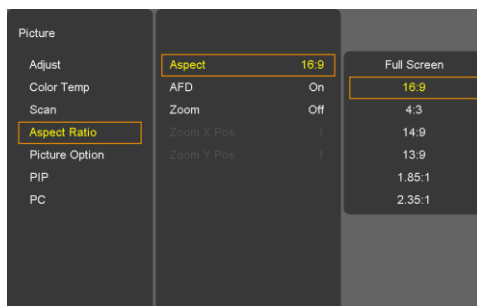

- For setting the aspect ratio.

- Full Screen: The images are displayed with a panel size.

- Full Screen, 16:9, 4:3, 14:9, 13:9, 1.85:1, 2.35:1: The images are displayed with each aspect ratio.

- PC mode: Full Screen & 4:3 only

- AFD (Active Format Description): If this mode is selected, the embedded Aspect ratio signal in the video signal will be extracted and displayed as a marker.

● ZOOM



- Can see the enlarged picture by (2X, 3X, 4X, 5X) ratios.
- If user select the Zoom 2X, can see the below yellow box in picture.
- Press Select or Enter button, user can see the enlarged picture.
- Menu key escape the zoom mode.

Picture Option

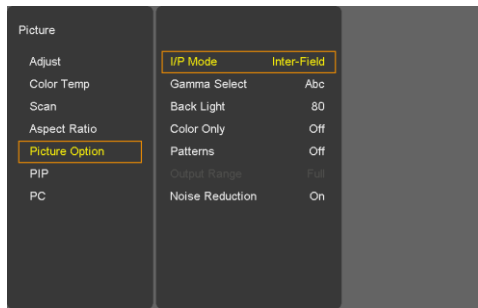

● I/P Mode

→ Line Doubler/inter-Field/Field Merge function on/off

● Gamma Select

→ Gamma Level Select (0.8 ~ 3.0)

● Back Light

→ Inverter dimming Level select (0~100)

● Color Only

→ Mono Color/Blue only Function on/off

- Mono color: For selecting monochrome images.
- Blue Only: Images have only blue color expect red and green color

● Patterns

→ Auto Run, 100% Color Bars, 75% Color Bars, Luma, RGB, White, Black, RED, Blue, Green

● Output Range

→ Normal (16~235)/Full (0~255)

● Noise Reduction

- Noise Reduction on/off. (NR is for Video signal (HD-SDI, CVBS, S-Video and Y.Pb.Pr) & DTV timing.

PIP (Picture IN Picture)

- Watch two programs or source at the same time. And set up PIP size and position.

● PIP ON/OFF

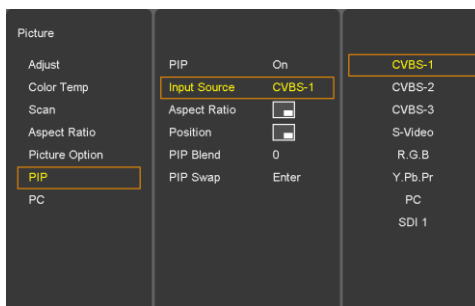

- Control PIP function On/Off.

● Input Source

- PIP input Source can operate with different signal and type.
- SDI1, Analog (CVBS 1, 2, 3, Y.Pb.Pr, GBR, PC) inputs +SDI2, Digital (DVI, HDMI) inputs
- SDI + SDI input PIP
- Ex) AV + S-Video (X), DVI + SDI1 (O), PC + DVI (O), HDMI+SDI2 (X)
- PIP MATRIX TABLE

	SDI 1	SDI 2	HDMI-DVI	PC_YPbPr_RGB_YC_CVBS
SDI 1	X	O	O	X
SDI 2	O	X	X	O
HDMI-DVI	O	X	X	O
PC_YPbPr_RGB_YC_CVBS	X	O	O	X

● Aspect

- Choose PIP size of Small/POP1/POP2

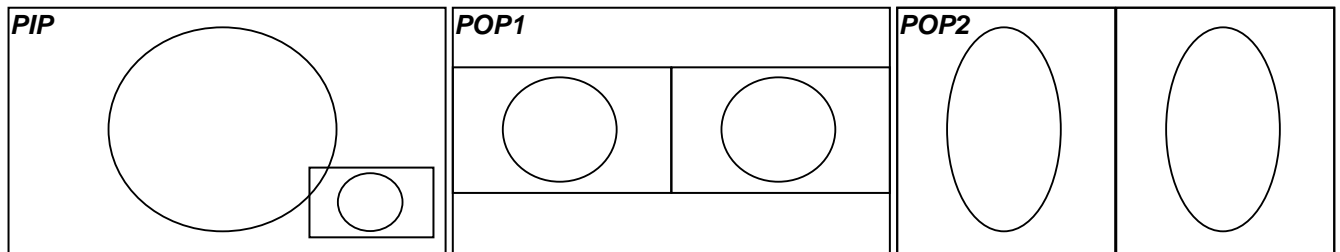

● Position

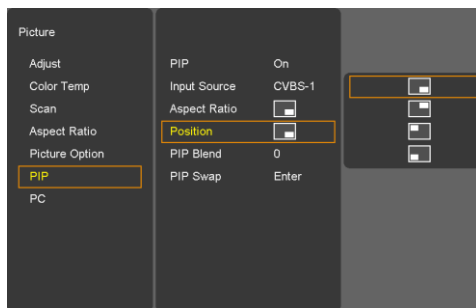

- Choose the pip position on the each corner of the pane

● PIP Blend

- Blend to PIP size of Small

● PIP Swap

- Using Swap option, you can exchange two programs or source at the same time.

PC Menu

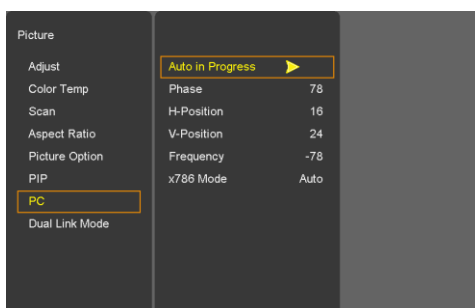

- Only operate PC input mode
- Select Auto-adjust and adjust Phase, HV position, Frequency
- Auto-Adjust automatically set the optimum values of Phase, HV position and Frequency.
- Selects X788 native PC video timings. (Auto/1024x/1280x/1360x/1366x)

Marker

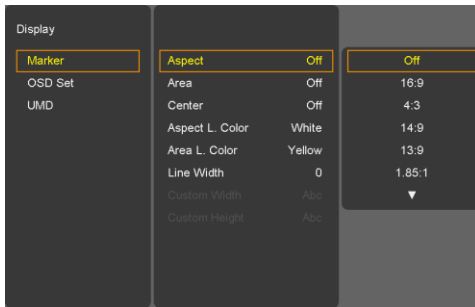

- **Aspect**

- 16:9, 4:3, 14:9, 13:9, 1.85:1, 2.35:1, 1.85:1&4:3, Custom fitted panel size marker on screen.

- **Area**

- Area: Draw dotted line Marker on screen in case of images. (16:9 95/93/90/88/80%, 4:3 95/93/90/88/80%, EBU Action 16:9/14:9/4:3, EBU Graphic 16:9/14:9/4:3)

- **Center**

- "+" Marker on center of screen

- **Aspect L. Color**

-Marker Line Color Select. (WHITE, YELLOW, BLUE, RED, BLACK)

- **Area L. Color**

-Area Line Color Select. (WHITE, YELLOW, BLUE, RED, BLACK)

- **Line Width**

- Marker line thickness setting. (0~10)

- **Custom Marker**

-The user wants Marker size setting. (Below panel size)

OSD Set

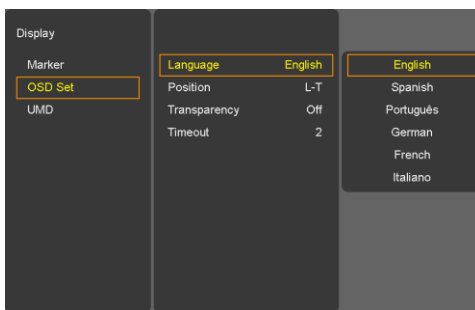

- **Language**

-Select a language for the menus to appear in. (English, Spanish, Portuguese, German, French, Italian)

- **Position**

- L-T, R-T, C, L-B, R-B

- **Transparency**

- Disable blending OSD background with video image.

- **Timeout**

- OSD gone time setting. (3~200)

U.M.D

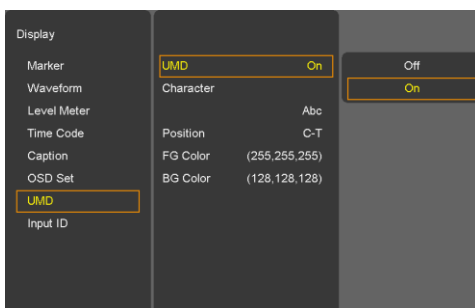

UMD



Tally Red



Tally Green

- **UMD**

- UMD display on/off

- **Character**

- UMD Character Select

- **Position**

- UMD display position select. (L-T, C-T, R-T, L-B, C-B, R-B)

- **FG Color**

- UMD Character color Select (RGB_255_192_128_0_Transparent)

- **BG Color**

- UMD BG color Select (RGB_255_192_128_0_Transparent)

Setup Load & Setup Save

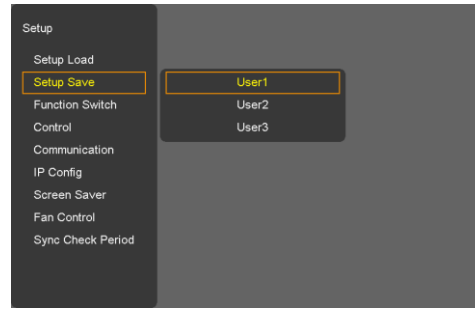
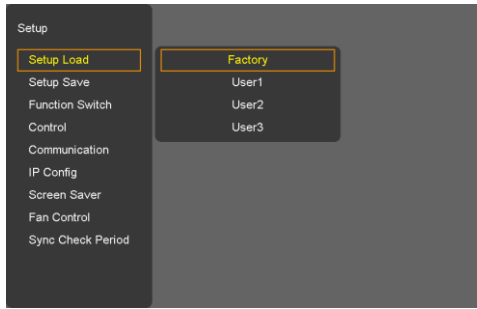

- Setup Load: Load user saved values or default value
- Setup Save: Save user setting values at user 1, 2, 3.

Function Switch

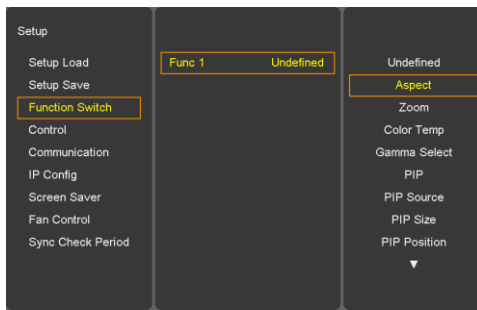

- Function 1: Select the function to be allocated to the FUNCTION 1, 2 buttons

Function1 button	Description
Undefined	Not set (no function allocated)
Zoom	Zoom function on/off
Color Temp	Color Temp Select
Gamma Select	Gamma Select
PIP	PIP on/off
PIP Source	PIP Source Select
PIP Size	PIP Size Select
PIP Postion	PIP Postion Select
PIP Swap	PIP Swap
Input Composite	Input Composite
Input PC	Input PC Select
Input HDMI	Input HDMI Select
Input DVI	Input DVI Select

Control

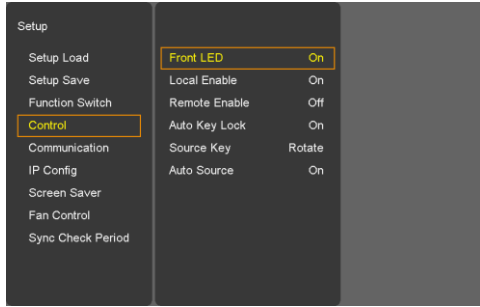

- **Front LED**
- Front LED on/off
- **Local Enable**
- Power, up and down key is only worked, if Local enable is off.
- **Remote Enable**
- Select the controller of local or remote. If remote controller is selected, both local (front key) and remote are worked. However select local, local key only operated.

- **Auto Key Lock**

- If it does not work 10 minutes to lock automatically. Key button is operated after being pressed about 2 seconds

- **Source Key (Front "Input" Button / Remote Controller "Source" Button)**

- Menu: Select the input signals to the input menu OSD.

- Rotate: Press Button to rotate the input source.

- **Auto Source**

- When there is no input signal, Auto Source change.

Communication

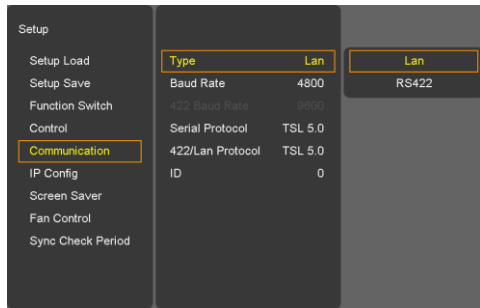

- **Type**
- Select the Communication: RS-422 or Lan
- **Baud Rate**
- 2400/4800/9600/19200/38400/57600/115200
- **422 Baud Rate (Only RS-422)**
- 2400/4800/9600/19200/38400/57600/115200
- **Serial Protocol**
- Basic / TSL 5.0 / TSL 4.0 / RDU / Extension

- **422/Lan Protocol**

- Basic / TSL 5.0 / TSL 4.0 / RDU / Extension

- **ID (01~99)**

- If control each Board, must set ID numbers of each Board

IP Config

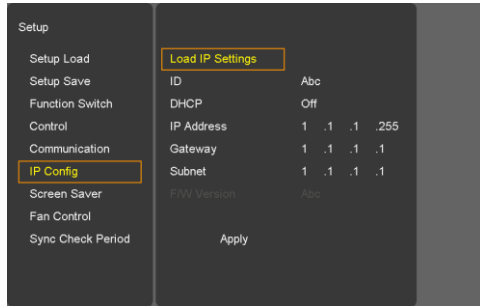

→ Load Network Settings: ETHERNET cable connected after "Enter". (ID/IP Address/Gateway/Subnet Load)

→ DHCP: DHCP on/off (Manual IP settings – DHCP on)

* "Apply" enter all settings after.

Screen Saver

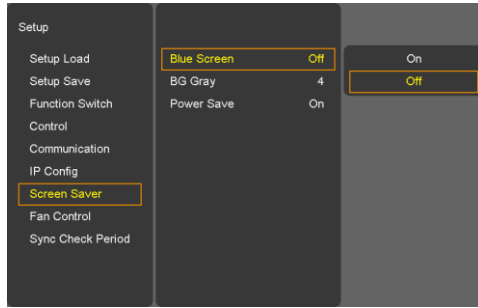

- **Blue Screen**
 - Enables screen saver functions to avoid panel burning.
- **BG Gray**
 - Select gray level on besides display picture. (0~7)
- **Power Save**
 - DPMS (Display Power Management Signaling) Power Save Mode.

SETUP MENU

Fan Control

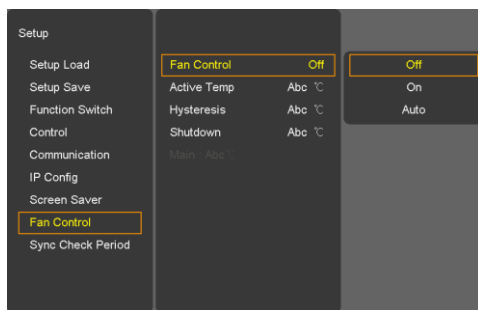

- **Fan Control**
 - Internal Fan Controls driving option by temperature sensor **Auto** / force **on** / force **off**
 - **Active Temp**
 - Adjusts fan driving temperature by Celsius degree. It works only when the Fan Control setting is Auto.
 - **Hysteresis**
 - Adjusts fan driving hysteresis temperature by Celsius degree. (1~10 °C)
 - **Shutdown**
 - For a monitor protection is above of 75 °C, Power Off.

Sync Check Period

- Sync Check Period at when switching the input signal (10 ~ 300 ms)

Info MENU



- Model, H/W Version, FPGA, F/W Release, Operating Time, Cal. ID

Supported Signals

Items		Specifications
Supported Signals	Serial Digital Interface	HD SDI- 2.970Gbps
		SD HDI- 270Mbps
	HDMI DVI-I (DVI+VGA_IN)	H Frequency Range : 20~82 kHz
		V Frequency Range : 55 ~ 90 Hz
		Maximum resolution : 1920x1080 60Hz
		Maximum pixel rate : 162 MHz
		DTV mode support : 720P, 1080i, 1080p
	ANALOG RGB	H Frequency Range : 20~82 kHz
		V Frequency Range : 55 ~ 90 Hz
		Maximum resolution : 1920x1080 60Hz
		Maximum pixel rate : 162 MHz
		DTV mode support: 720P/1080i/1080p
		SOG sync support
	ANALOG Component (DTV/DVD)	1080p/1080i/720P/480i/576i/480P/576P
	CVBS	NTSC/PAL/SECAM

Supported Timings

- SDI input

SMPTE-425M(3G)	1920x1080P(50/60)
SMPTE-259M	1920x1080i(50)
SMPTE-274M	1920x1080i (50/59.94/60)
SMPTE-296M	1280x720P (50/59.94/60)
SMPTE-125M	480i(59.94)
ITU-R BT.601	576i(50)

- PC & DVI input

Section	Resolution	H Frequency(kHz)	V Frequency(Hz)	Pixel Frequency(MHz)	Comment
PC	640x400	37.861	85.08	31.5	
	640x350	31.469	70.087	25.175	
	640x350	37.861	85.08	31.5	
	640x480	31.469	59.94	25.175	
	640x480	35.000	66.667	30.24	
	640x480	34.940	69.884	28.513	
	640x480	37.861	72.809	29.765	
	640x480	37.500	75.0	31.5	
	640x480	43.269	85.008	36.0	
	640x480	45.540	90.0	37.889	
	720x400	31.469	70.087	28.322	

	720x400	37.927	85.039	35.5	
	800x600	35.156	56.25	36.0	
	800x600	37.879	60.317	40.0	
	800x600	43.764	70.02	45.513	
	800x600	48.077	72.188	50.0	
	800x600	46.875	75.0	49.5	
	800x600	53.674	85.061	56.25	
	800x600	56.880	90.0	60.065	
	832x624	49.726	74.551	57.284	
	1024x768	48.780	60.001	64.11	
	1024x768	48.363	60.004	65.0	
	1024x768	56.476	70.069	75.0	
	1024x768	57.703	72.039	78.476	
	1024x768	60.241	74.927	81.724	
	1024x768	60.030	75.029	78.75	
	1024x768	68.677	84.997	94.5	
	1024x768	72.810	90.0	100.187	
	1152x864	53.700	60.0	81.624	
	1152x864	62.932	69.924	96.663	
	1152x864	67.500	75.0	104.993	
	1152x870	68.681	75.062	100.0	
	1152x900	61.846	66.0	94.787	
	1152x900	72.713	76.047	105.561	
	1280x720	47.760	60.0	74.481	
	1280x720	52.500	70.0	89.040	
	1280x720	54.072	72.0	91.706	
	1280x720	56.400	75.0	95.654	
	1280x768	60.150	75.0	102.977	
	1280x960	60.000	60.0	102.104	
	1280x960	59.640	60.0	102.104	
	1280x1024	63.337	59.978	108.18	
	1280x1024	63.981	60.02	108.0	
	1280x1024	64.754	60.06	108.992	
	1280x1024	63.600	60.0	108.883	
	1360x768	47.700	60.0	84.700	
	1600x1200	75.000	60.0	162.000	
DTV	720x480	15.735	59.94	13.500	<i>Interlaced</i>
	720x576	15.735	50.0	13.595	<i>Interlaced</i>
	720x480	31.469	59.94	25.175	
	720x576	31.250	50.0	26.566	
	1280x720	44.964	59.94	74.176	
	1280x720	37.500	50.0	60.466	
	1920x1080	33.750	60.0	74.25	<i>Interlaced</i>
	1920x1080	28.125	50.0	70.723	<i>Interlaced</i>
	1920x1080	31.250	50.0	72.000	<i>Interlaced</i>
	1920x1080	67.5	60	148.5	<i>Progressive</i>

LVB17

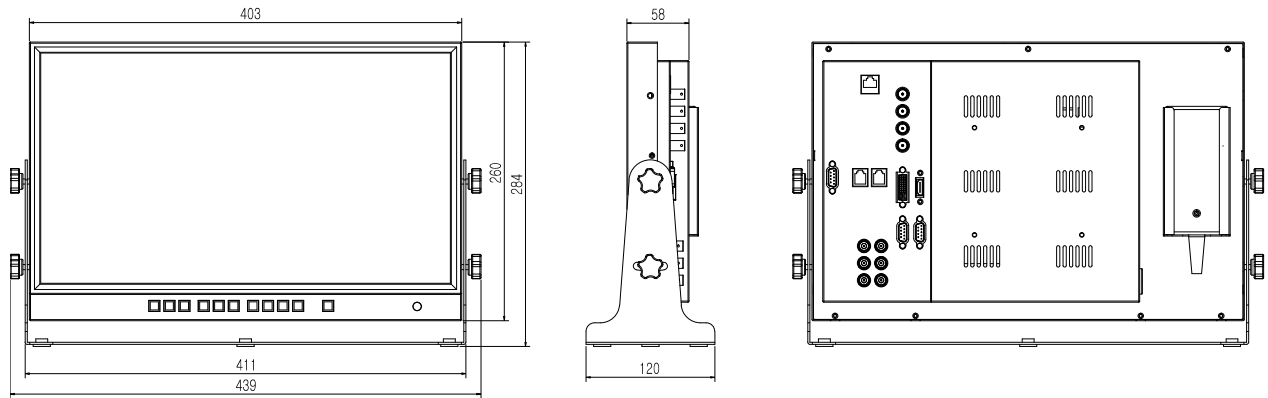

LVB23

